

Datasheet

Ultrasonic Sensor with TEACH-Mode Configuration



- 1, 2 and 3 m (3.28, 6.56, and 9.84 ft) versions with short dead zones (10% of max range)
- Built-in temperature compensation
- Fast, easy-to-use TEACH-Mode programming; no potentiometer adjustments
- Configure with either a positive or negative analog output slope
- Remote TEACH for security and convenience
- Wide operating temperature range of -40° to $+70^{\circ}$ C (-40° to $+158^{\circ}$ F)
- Choose either 0 to 10V dc or 4 to 20 mA output model
- Compact, self-contained, right-angle sensor package with fully encapsulated electronics

Models

Models	Range and Frequency	Cable ¹	Supply Voltage	Analog Output	Response Time
T30UXUA	100 mm to 1 m (3.9 in to 39 in)	Standard 2 m (6.5 ft) cable	10 to 30 V dc	0 to 10 V dc	45 ms or 105 ms selectable
T30UXIA	224 kHz			4 to 20 mA	
T30UXUB	200 mm to 2 m (7.8 in to 78 in)			0 to 10 V dc	92 ms or 222 ms selectable
T30UXIB	174 kHz			4 to 20 mA	
T30UXUC	300 mm to 3 m (11.8 in to 118 in)			0 to 10 V dc	135 ms or 318 ms selectable
T30UXIC	114 kHz			4 to 20 mA	



WARNING: Not To Be Used for Personnel Protection

Never use this device as a sensing device for personnel protection. Doing so could lead to serious injury or death. This device does not include the self-checking redundant circuitry necessary to allow its use in personnel safety applications. A sensor failure or malfunction can cause either an energized or de-energized sensor output condition.

Overview

The U-GAGE® T30UX is an easy-to-use ultrasonic sensor with extended range and built-in temperature compensation. Simple push button configuration provides flexibility for a variety of applications.

Easy-to-see indicator LEDs communicate the status of the sensor. The Green “Power” LED ON indicates that the sensor is in Run Mode (the sensor’s normal operating condition). The Red “Signal” LED indicates the target signal strength. The Amber “Output” LED indicates that the output is enabled and the sensor is receiving a signal within the window limits. The Amber “Mode” LED indicates the currently selected mode (fast or slow).



Figure 1. Features

¹ Only standard 2 m (6.5 ft) cable models are listed. To order the 4-Pin Euro-Style integral QD, add suffix “Q8” to the model number (for example, T30UXUAQ8). To order the 150 mm (6 in) PUR pigtail cable with 4-Pin threaded Euro-Style QD, add suffix “QPMA” to the model number (for example, T30UXUAQPMA). To order the 9 m (30 ft) cable, add suffix “W/30” to the model number (for example, T30UXUA W/30). A model with a QD connector requires a mating cable; see [Quick-Disconnect Cables](#) on page 10.



Principles of Operation

Ultrasonic sensors emit one or multiple pulses of ultrasonic energy, which travel through the air at the speed of sound. A portion of this energy reflects off the target and travels back to the sensor. The sensor measures the total time required for the energy to reach the target and return to the sensor. The distance to the object is then calculated using the following formula: $D = ct \div 2$

D = distance from the sensor to the target

c = speed of sound in air

t = transit time for the ultrasonic pulse

To improve accuracy, an ultrasonic sensor may average the results of several pulses before outputting a new value.

Temperature Effects

The speed of sound is dependent upon the composition, pressure and temperature of the gas in which it is traveling. For most ultrasonic applications, the composition and pressure of the gas are relatively fixed, while the temperature may fluctuate.

In air, the speed of sound varies with temperature according to the following approximation:

In metric
units:

$$C_{m/s} = 20 \sqrt{273 + T_C}$$

$C_{m/s}$ = speed of sound in meters per second

T_C = temperature in °C

In English units:

$$C_{ft/s} = 49 \sqrt{460 + T_F}$$

$C_{ft/s}$ = speed of sound in feet per second

T_F = temperature in °F

Temperature Compensation

Changes in air temperature affect the speed of sound, which in turn affects the total time for the echo measured by the sensor. An increase in air temperature shifts both sensing window limits closer to the sensor. Conversely, a decrease in air temperature shifts both limits farther away from the sensor. This shift is approximately 3.5% of the limit distance for a 20° C change in temperature.

The T30UX series ultrasonic sensors are temperature compensated. This reduces the error due to temperature by about 90%. The sensor will maintain its window limits to within 2.2% over the -40° to +70° C (-40° to +158° F) operating range of the sensor.



NOTE:

- Exposure to direct sunlight can affect the sensor's ability to accurately compensate for changes in temperature.
- If the sensor is measuring across a temperature gradient, the compensation will be less effective.

Configuration Instructions

Sensor Configuration

Two TEACH methods may be used to configure the sensor:

- Teach individual minimum and maximum limits, or
- Use Auto-Window feature to center a sensing window around the taught position.

The sensor may be configured either via its push button, or via a remote switch. Remote configuration also may be used to disable the push button, preventing unauthorized personnel from adjusting the configuration settings. To access this feature, connect the white wire of the sensor to 0V dc, with a remote configuration switch between the sensor and the voltage.

Configuration is accomplished by following the sequence of input pulses. The duration of each pulse (corresponding to a push button "click"), and the period between multiple pulses, are as "T": 0.04 seconds < T < 0.8 seconds

Remote line configuration requires a greater than 1 second pause between pulse sequences.

Mode Setup - Response Speed

Analog sensor models can be set up for either "Fast" or "Slow" response time. A button click or pulse on the remote line is: 0.04 s < T < 0.8 s.

1. Enter Response Speed Mode setup mode.

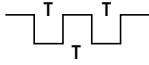
Method	Action	Result
Push Button	Push and hold MODE push button for > 2 seconds.	Power LED: OFF Mode LED: Flashing Amber shows previously selected mode
Remote Input	Double-pulse the remote line. 	Power LED: OFF Mode LED: Flashing Amber shows previously selected mode

2. Select the speed.

Method	Action	Result
Push Button	Click the MODE button to cycle to the correct selection: Fast or Slow.	Power LED: OFF Mode LED: Amber flashes to indicate currently selected mode (120 second time out ²)
Remote Input	Single-pulse to select Slow; double-pulse to select Fast.	Power LED: ON Green Mode LED: ON Amber shows selected mode (Sensor returns to RUN mode)

3. Save and return to Run mode.

Method	Action	Result
Push Button	Push and hold the MODE button for more than 2 seconds.	Power LED: ON Green Mode LED: ON Amber for selected mode
Remote Input	No action is required; the sensor will return to Run Mode.	None

Analog Output

The U-GAGE T30UX series sensor may be configured for either a positive or a negative output slope, based on which condition is taught first (see *Figure 2* on page 3). If the near limit is taught first, the slope will be positive; if the far limit is taught first, the slope will be negative. Banner's scalable analog output automatically distributes the output signal over the width of the programmed sensing window.

The U-GAGE T30UX also features a 2-second hold upon loss of the received signal, which is useful for harsh and unstable applications. In the event of signal loss for longer than 2 seconds, the analog output goes to 3.6 mA or 0V dc, which may be used to trigger an alarm.

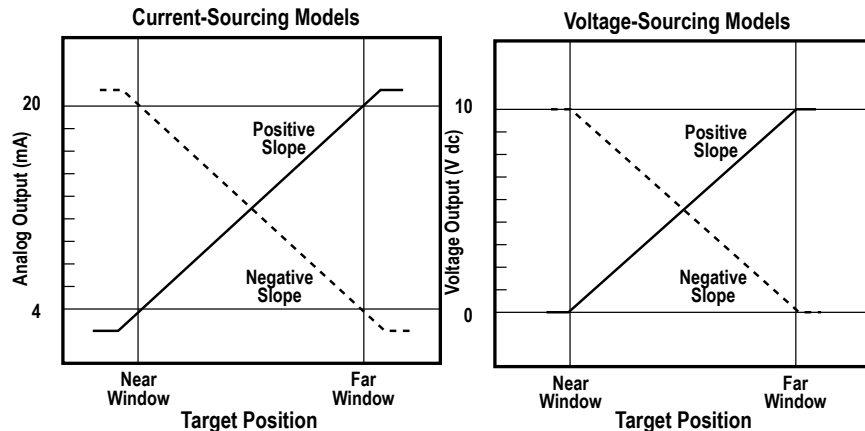

Figure 2. Positive and Negative Output Slopes

Teaching Minimum and Maximum Limits

General Notes on Teaching

- The sensor returns to RUN mode if the first TEACH condition is not registered within 120 seconds after the initial 2 second hold on the Analog button.

² The sensor will revert to previously saved configuration and return to RUN mode if TEACH is inactive for 120 seconds after the initial 2 second hold on push button

- To exit TEACH mode without saving any changes, press and hold the Analog button or remote line longer than 2 seconds (before teaching the second limit). The sensor reverts to the last saved limits.
 - After the first limit is taught, the sensor remains in TEACH mode until the TEACH sequence is finished or exited by a 2 second hold on the Analog button or remote line.
 - A button click or pulse on the remote line is: $0.04\text{ s} < T < 0.8\text{ s}$.
- Enter TEACH mode.

Method	Action	Result
Push Button	Push and hold the Analog push button longer than 2 seconds.	Power LED: OFF Output LED: ON
Remote Input	No action required; sensor is ready for first limit teach.	None

- Teach the first limit.

Method	Action	Result
Push Button	Position the target for the first limit (120 second time out).	Signal LED: Must be ON Red or Flashing Red ³
	"Click" the Analog button.	Teach Accepted Power LED: OFF Output LED: Flashing Teach Not Accepted Output LED: ON
Remote Input	Position the target for the first limit.	Signal LED: Must be ON Red or Flashing Red ³
	Single-pulse the remote line. 	Teach Accepted Power LED: OFF Output LED: Flashing Teach Not Accepted Power LED: ON

- Teach the second limit.

Method	Action	Result
Push Button	Position the target for the second limit (no time out).	Signal LED: Must be ON Red or Flashing Red
	"Click" the Analog button.	Teach Accepted Output LED: ON Power LED: ON Teach Not Accepted Output LED: Flashing Power LED: OFF
Remote Input	Position the target for the second limit (no time out).	Signal LED: Must be ON Red or Flashing Red.
	Single-pulse the remote line. 	Teach Accepted Output LED: Turns ON Power LED: ON Teach Not Accepted Output LED: Flashing Power LED: OFF

Teaching Limits Using the Auto-Window Feature

Teaching the same limit twice automatically centers a 100 mm window on the taught position .

General Notes on Teaching

- The sensor returns to RUN mode if the TEACH condition is not registered within 120 seconds after the initial 2 second hold on the Analog button.
- To exit TEACH mode without saving any changes, press and hold the Analog button or remote line longer than 2 seconds (before teaching the second limit). The sensor will revert to the last saved limits.

³ Sensor will not Teach or indicate "Teach Not Accepted" when there is no signal present (Signal LED Red or Flashing Red)

- After the first limit is taught, the sensor remains in TEACH mode until the TEACH sequence is finished or exited by a 2 second hold on the Analog button or remote line.
- A button click or pulse on the remote line is: $0.04\text{ s} < T < 0.8\text{ s}$.

1. Enter TEACH mode.

Method	Action	Result
Push Button	Push and hold the Analog button longer than 2 seconds.	Power LED: OFF Output LED: ON
Remote Input	No action required; the sensor is ready for the first limit teach.	None

2. Teach the first limit.

Method	Action	Result
Push Button	Position the target for the center of window (120 second time out).	Signal LED: Must be ON Red or Flashing Red ⁴
	Click the Analog push button.	Teach Accepted Power LED: OFF Output LED: Flashing Teach Not Accepted Output LED: ON
Remote Input	Position the target for the center of window.	Signal LED: Must be ON Red or Flashing Red ⁴
	Single-pulse the remote line. 	Teach Accepted Power LED: OFF Output LED: Flashing Teach Not Accepted Output LED: ON

3. Re-teach the limit.

Method	Action	Result
Push Button	Without moving the target, "click" the Analog push button again	Teach Accepted Output LED: ON Power LED: ON Teach Not Accepted Output LED: Flashing Power LED: OFF
Remote Input	Without moving the target, single-pulse the remote line again. 	Teach Accepted Output LED: ON Power LED: ON Teach Not Accepted Output LED: Flashing Power LED: OFF

Remote Line TEACH

General Notes

- Run Mode is the sensor's normal operating condition
- The duration of each Pulse is defined as "T": $0.04 < T < 0.8\text{ s}$



- A Hold will exit TEACH MODE and return to Run Mode with previously saved changes. The duration of a Hold is: $T > 2\text{ s}$
- A Timeout will occur if a condition is not registered within 120 seconds, causing the sensor to return to Run Mode (during sensor configuration only)
- Sensor configuration user feedback shown on Green LED. See flowchart.

⁴ Sensor will not Teach or indicate "Teach Not Accepted" when there is no signal present (Signal LED Red or Flashing Red)

- The Red Signal LED will be ON whenever the target is in view.

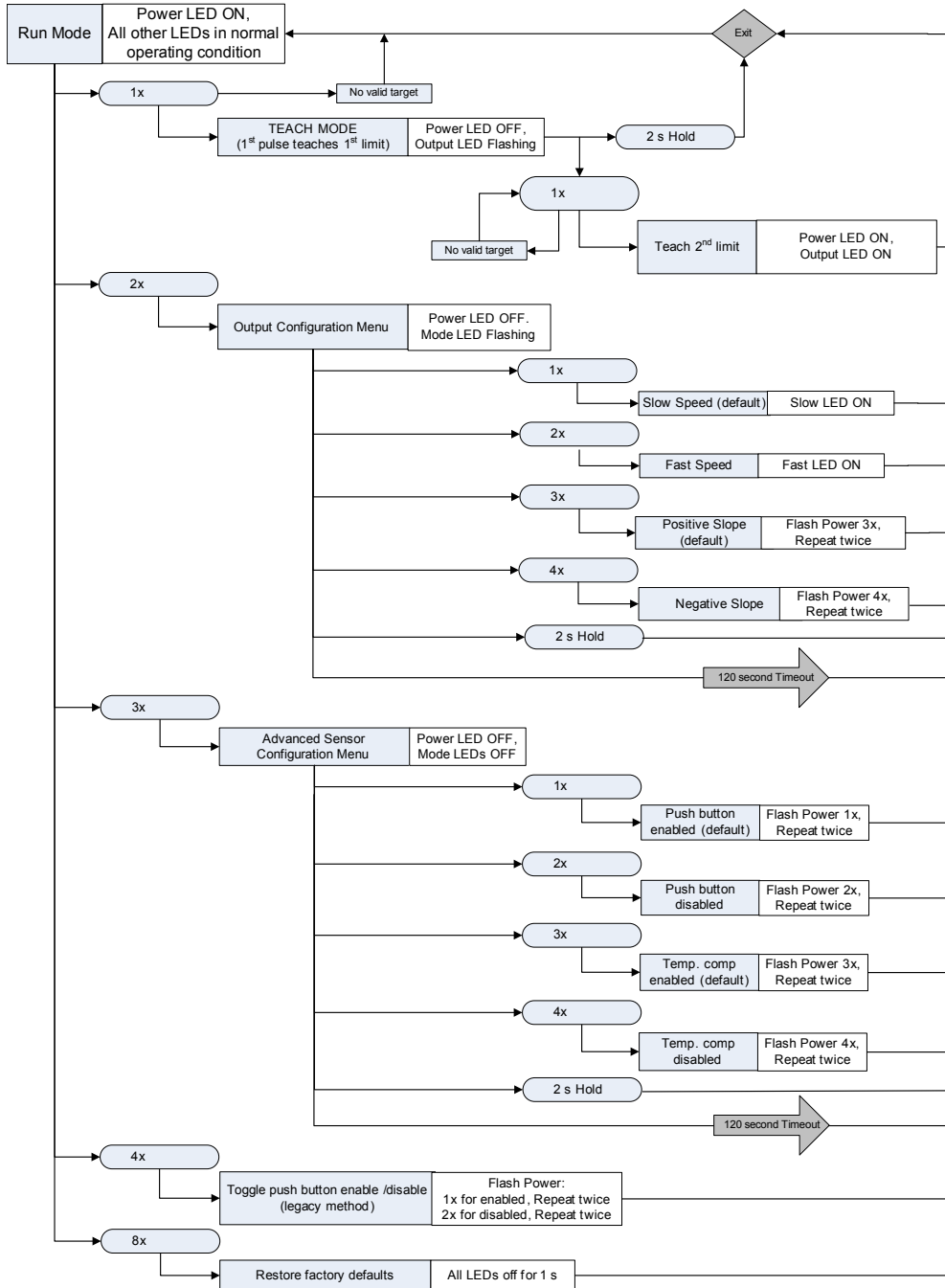

Wiring

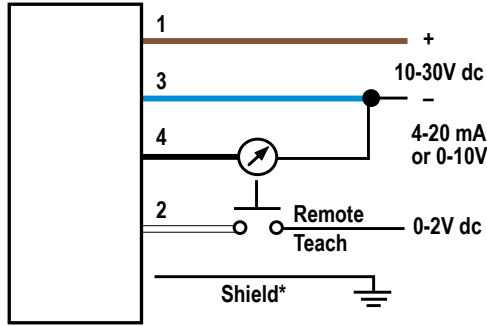

Wiring Key

- 1 = Brown
- 2 = White
- 3 = Blue
- 4 = Black

Cable and QD hookups are functionally identical. It is recommended that the shield wire be connected to earth ground. Shielded cordsets are recommended for all QD models.

Specifications

Sensing Range

- "A" suffix models: 100 mm to 1 m (3.9 in to 39 in)
- "B" suffix models: 200 mm to 2 m (7.8 in to 78 in)
- "C" suffix models: 300 mm to 3 m (11.8 in to 118 in)

Ultrasonic Frequency

- "A" suffix models: 224 kHz
- "B" suffix models: 174 kHz
- "C" suffix models: 114 kHz

Supply Voltage

10 to 30 V dc (10% maximum ripple) at 40 mA, exclusive of load

Supply Protection Circuitry

Protected against reverse polarity and transient voltages

Output Configuration

Analog Output: 0 to 10V dc or 4 to 20 mA, depending on model

Output Rating

Analog Voltage Output: 2.5 k Ω min. load resistance; Minimum supply for a full 10V output is 12V dc (for supply voltages between 10 and 12, V out max. is at least V supply -2)
 Analog Current Output: 1 k Ω max. at 24V input; max. load resistance = $(V_{cc}-4)/0.02\Omega$
 For current output (4-20 mA) models, ideal results are achieved when the total load resistance
 $R = [(V_{in} - 4)/0.020]\Omega$. Example, at $V_{in} = 24V$ dc, $R \approx 1$ k Ω (1 watt)

Output Protection Circuitry

Protected against short circuit conditions

Linearity

0.25% of distance

Resolution

- "A" suffix models: 0.1% of distance (0.5 mm min.)
- "B" suffix models: 0.1% of distance (1.0 mm min.)
- "C" suffix models: 0.1% of distance (1.5 mm min.)

Minimum Window Size

10 mm (0.4 in)

Adjustments

Sensing window limits: TEACH-Mode of near and far window limits may be set using the push button or remotely via TEACH input.
 Response speed selection: Fast or Slow (see [Mode Setup - Response Speed](#) on page 2 or [Remote Line TEACH](#) on page 5)
 Advanced configuration options: Analog output slope, push button enabled/disabled, temperature compensation enabled/disabled (see [Remote Line TEACH](#) on page 5)

Indicators

See [Figure 1](#) on page 1

Loss of Signal Indication

0 to 10V dc models: Analog output goes to 0V
 4 to 20 mA models: Analog output goes to 3.6 mA

Construction

Housing: PBT polyester
 Push buttons: polyester
 Transducer: epoxy /ceramic composite

Environmental Rating

Leakproof design, rated IEC IP67 (NEMA 6)

Connections

2 m (6.5 ft) or 9 m (30 ft) shielded 4-conductor (with drain) PVC cable, 150 mm (6 in) PUR Euro-style pigtail (QPMA), or 4-pin integral Euro-style connector (Q8)

Temperature Effect

0.02% of distance/ $^{\circ}C$

Delay at Power-up

500 ms

Output Response Time

- "A" suffix models: 45 ms (fast); 105 ms (slow)
- "B" suffix models: 92 ms (fast); 222 ms (slow)
- "C" suffix models: 135 ms (fast); 318 ms (slow)

Operating Conditions

Temperature: -40 °C to +70 °C (-40 °F to +158 °F)
 Humidity: 95% at +50 °C maximum relative humidity (non-condensing)

Vibration and Mechanical Shock

All models meet Mil. Std. 202F requirements method 201A (vibration: 10 to 60 Hz max., double amplitude 0.06 in, max acceleration 10G). Also meets IEC 947-5-2; 30G 11 ms duration, half sine wave

Certifications



Application Note

The temperature warmup drift upon power-up is less than 1% of the sensing distance.

Required Overcurrent Protection



WARNING: Electrical connections must be made by qualified personnel in accordance with local and national electrical codes and regulations.

Overcurrent protection is required to be provided by end product application per the supplied table.

Overcurrent protection may be provided with external fusing or via Current Limiting, Class 2 Power Supply.

Supply wiring leads < 24 AWG shall not be spliced.

For additional product support, go to <http://www.bannerengineering.com>.

Supply Wiring (AWG)	Required Overcurrent Protection (Amps)
20	5.0
22	3.0
24	2.0
26	1.0
28	0.8
30	0.5

Performance Curves

With Plate Target (Typical)

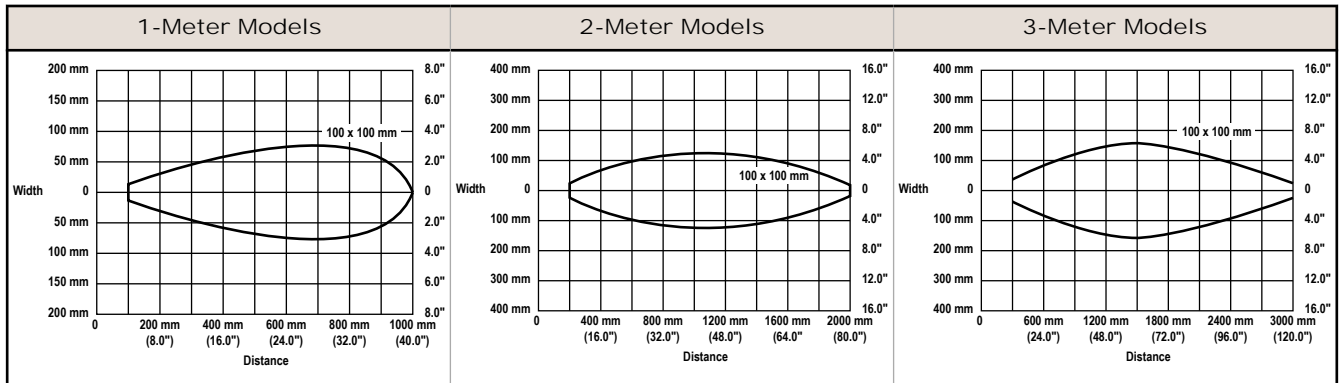

With Rod Target (Typical)

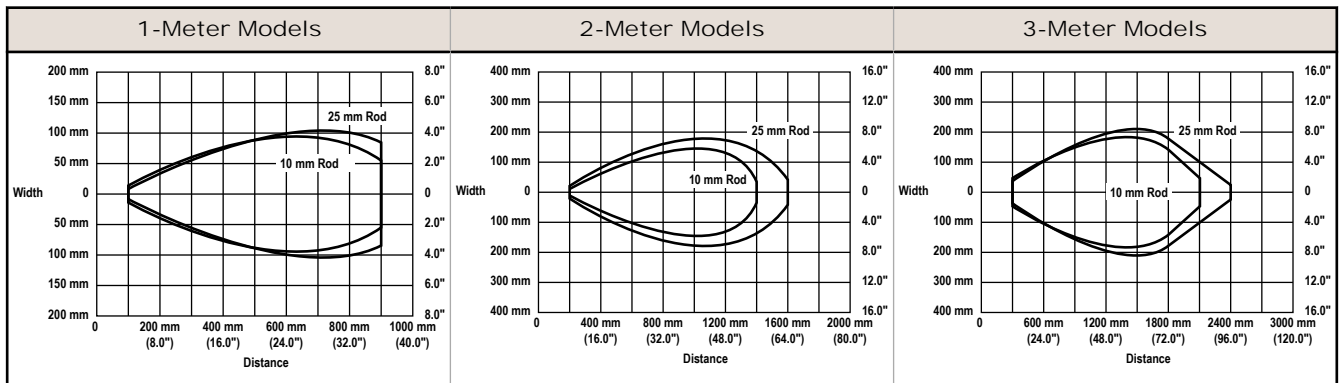

Maximum Target Rotation Angle

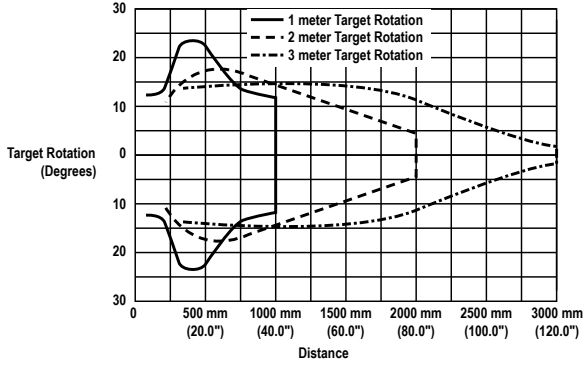

Dimensions

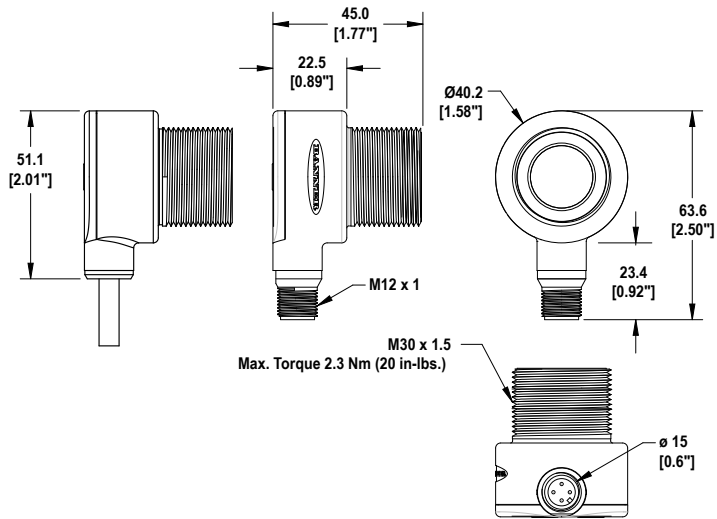

Locknut (included with all models)

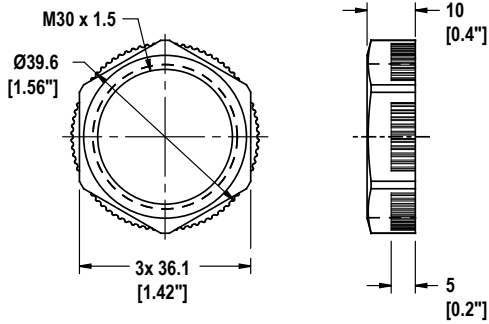

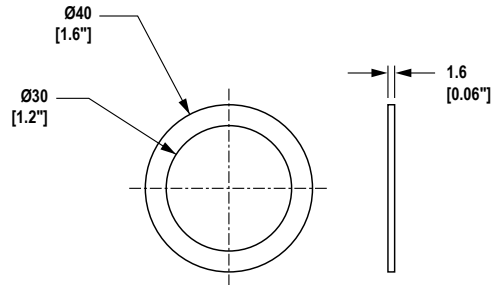

Washer (included with all models)

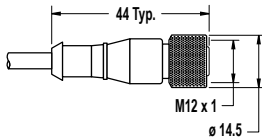

Accessories

Quick-Disconnect Cables

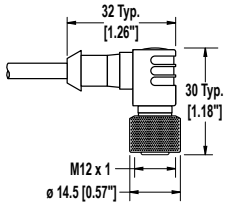
4-Pin Threaded M12/Euro-Style Cordsets with Shield				
Model	Length	Style	Dimensions	Pinout (Female)
MQDEC2-406	1.83 m (6 ft)	Straight		 <p>1 = Brown 2 = White 3 = Blue 4 = Black</p>
MQDEC2-415	4.57 m (15 ft)			
MQDEC2-430	9.14 m (30 ft)			
MQDEC2-406RA	1.83 m (6 ft)	Right-Angle		
MQDEC2-415RA	4.57 m (15 ft)			
MQDEC2-430RA	9.14 m (30 ft)			

Brackets

All measurements are in mm.

SMB30A

- Right-angle bracket with curved slot for versatile orientation
- Clearance for M6 (¼ in) hardware
- Mounting hole for 30 mm sensor
- 12-ga. stainless steel

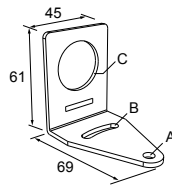

Hole center spacing: A to B=40
Hole size: A=ø 6.3, B= 27.1 x 6.3, C=ø 30.5

SMB1815SF

- Swivel with set screws for mounting sensors by the cable hub
- Black reinforced thermoplastic polyester
- Stainless steel swivel locking hardware and hex wrench included

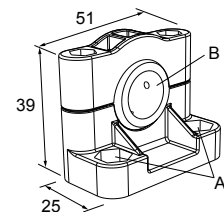

Hole center spacing: A = 36.0
Hole size: A = ø 5.0, B = ø 15.0

SMB30FA

- Swivel bracket with tilt and pan movement for precise adjustment
- Mounting hole for 30 mm sensor
- 12-ga. 304 stainless steel
- Easy sensor mounting to extrude rail T-slot
- Metric and inch size bolt available

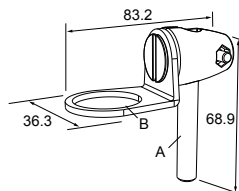

Bolt thread: SMB30FA, A= 3/8 - 16 x 2 in; SMB30FAM10, A= M10 - 1.5 x 50
Hole size: B= ø 30.1

SMB30SC

- Swivel bracket with 30 mm mounting hole for sensor
- Black reinforced thermoplastic polyester
- Stainless steel mounting and swivel locking hardware included

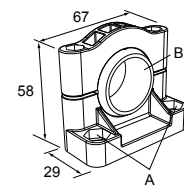

Hole center spacing: A=ø 50.8
Hole size: A=ø 7.0, B=ø 30.0